

Model: D2DB-50 X

Data

Type: Semi-hermetic piston compressors

Producer: Copeland

Series: DISCUS

Model: D2DB-50 X

Technical data

Cylinder count:	2
Displacement [m ³ /h]:	28
Weight [kg]:	140
Oil charge [dm ³]:	2,3
Max. operating current [A]:	11,5
Locked rotor current [A]:	55
Power supply [V/~/Hz]:	380-420V/3/50Hz

Connections

	<u>milimeters</u>	<u>inches</u>
Suction line:		1 3/8"
Discharge line:		7/8"

Model: D2DB-50 X

Capacity

R134a

Cooling capacity [kW]

$t_c \setminus t_e$	-20	-15	-10	-5	0	5	10
30	5.82	7.80	10.17	12.97	16.27	20.12	24.58
35	5.24	7.15	9.42	12.10	15.25	18.93	23.19
40	4.70	6.52	8.68	11.22	14.21	17.71	21.76
45	4.18	5.91	7.94	10.34	13.16	16.45	20.29
50	3.69	5.31	7.21	9.45	12.08	15.17	18.77
55	3.24	4.73	6.48	8.55	10.99	13.86	17.21
60	2.81	4.17	5.76	7.65	9.88	12.51	15.61

Power input [kW]

$t_c \setminus t_e$	-20	-15	-10	-5	0	5	10
30	2.44	2.71	2.93	3.10	3.21	3.23	3.16
35	2.52	2.84	3.12	3.36	3.54	3.64	3.66
40	2.59	2.95	3.29	3.59	3.84	4.02	4.12
45	2.65	3.06	3.45	3.80	4.11	4.36	4.54
50	2.70	3.15	3.58	3.98	4.35	4.67	4.92
55	2.74	3.21	3.68	4.14	4.56	4.94	5.25
60	2.76	3.26	3.77	4.26	4.73	5.16	5.54

Model: D2DB-50 X

Capacity

Current [A]

$t_c \setminus t_e$	-20	-15	-10	-5	0	5	10
30	5.88	6.17	6.42	6.63	6.75	6.78	6.68
35	5.97	6.32	6.64	6.93	7.15	7.28	7.30
40	6.05	6.45	6.85	7.21	7.52	7.76	7.89
45	6.12	6.57	7.03	7.47	7.87	8.20	8.45
50	6.17	6.67	7.18	7.70	8.18	8.61	8.97
55	6.21	6.75	7.32	7.90	8.47	8.99	9.46
60	6.22	6.80	7.43	8.07	8.72	9.33	9.90

Mass flow [kg/s]

$t_c \setminus t_e$	-20	-15	-10	-5	0	5	10
30	137.53	180.94	230.87	288.32	354.27	429.72	515.67
35	129.94	173.81	224.05	281.66	347.62	422.94	508.60
40	122.80	166.81	217.05	274.50	340.15	415.01	500.06
45	115.94	159.78	209.69	266.67	331.70	405.78	489.91
50	109.21	152.56	201.83	258.01	322.10	395.09	477.98
55	102.43	144.97	193.28	248.35	311.18	382.77	464.10
60	95.44	136.86	183.89	237.54	298.79	368.65	448.10

Model: D2DB-50 X

Capacity

C.O.P. [W/W]

$t_c \setminus t_e$	-20	-15	-10	-5	0	5	10
30	2.38	2.88	3.47	4.18	5.07	6.23	7.78
35	2.08	2.52	3.02	3.60	4.31	5.20	6.34
40	1.81	2.21	2.63	3.12	3.70	4.41	5.29
45	1.58	1.93	2.30	2.72	3.20	3.77	4.47
50	1.37	1.69	2.01	2.37	2.78	3.25	3.82
55	1.18	1.47	1.76	2.07	2.41	2.81	3.28
60	1.02	1.28	1.53	1.79	2.09	2.42	2.82

Application range

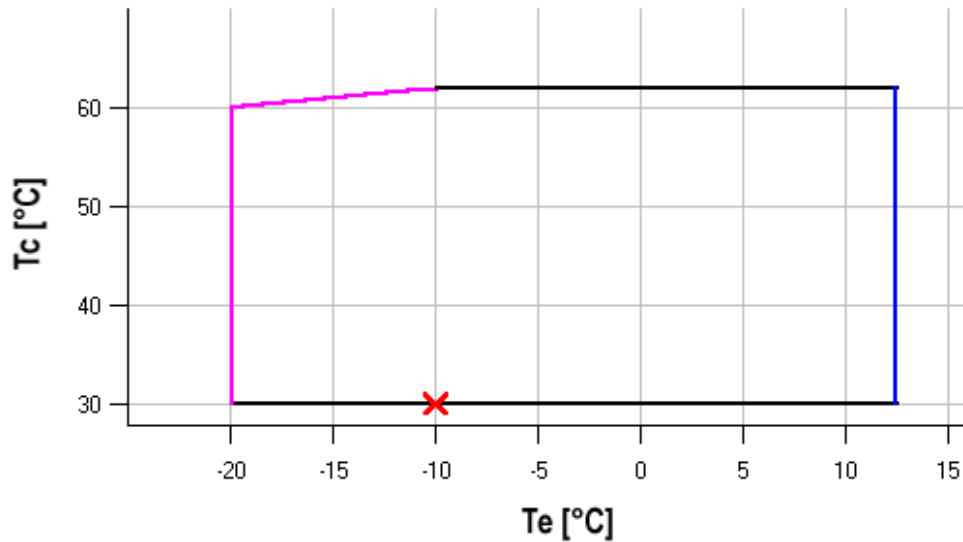

- Maximum evaporating temperature
- 25°C suction gas return

Operating conditions: ISO; subcooling: 0 K, suction superheat: 10 K, return gas temperature: -

t_c - Condensing temperature [°C]

t_e - Evaporating temperature [°C]

Model: D2DB-50 X

Capacity

R404A/R507

Cooling capacity [kW]

$t_c \setminus t_e$	-50	-45	-40	-35	-30	-25	-20	-15	-10
20	2.85	4.02	5.46	7.21	9.30	11.77	14.66	18.00	21.82
25	2.51	3.62	4.98	6.63	8.59	10.92	13.63	16.78	20.38
30	2.16	3.21	4.50	6.04	7.89	10.06	12.61	15.55	18.94
35	1.81	2.81	4.02	5.46	7.18	9.20	11.58	14.33	17.50
40	-	2.41	3.54	4.88	6.47	8.35	10.55	13.11	16.06
45	-	2.02	3.07	4.31	5.77	7.50	9.53	11.89	14.63
50	-	-	2.60	3.74	5.08	6.66	8.52	10.69	13.20
55	-	-	2.15	3.19	4.41	5.84	7.52	9.49	-

Power input [kW]

$t_c \setminus t_e$	-50	-45	-40	-35	-30	-25	-20	-15	-10
20	1.95	2.31	2.67	3.02	3.35	3.64	3.88	4.07	4.17
25	1.94	2.33	2.73	3.12	3.50	3.86	4.17	4.43	4.63
30	1.92	2.34	2.77	3.20	3.64	4.05	4.43	4.77	5.06
35	1.90	2.33	2.79	3.27	3.75	4.23	4.68	5.09	5.46
40	-	2.31	2.81	3.32	3.85	4.38	4.90	5.39	5.84
45	-	2.29	2.81	3.36	3.94	4.52	5.10	5.66	6.20
50	-	-	2.79	3.38	4.00	4.64	5.28	5.92	6.53
55	-	-	2.77	3.39	4.05	4.74	5.44	6.15	-

Model: D2DB-50 X

Capacity

Current [A]

$t_c \setminus t_e$	-50	-45	-40	-35	-30	-25	-20	-15	-10
20	5.46	5.83	6.21	6.60	6.97	7.31	7.60	7.83	8.00
25	5.44	5.84	6.26	6.70	7.13	7.55	7.94	8.28	8.57
30	5.42	5.84	6.30	6.79	7.29	7.79	8.27	8.72	9.13
35	5.39	5.83	6.33	6.87	7.44	8.02	8.59	9.15	9.68
40	-	5.81	6.35	6.94	7.57	8.23	8.90	9.56	10.21
45	-	5.77	6.34	6.98	7.68	8.42	9.18	9.96	10.73
50	-	-	6.31	7.00	7.77	8.58	9.44	10.32	11.21
55	-	-	6.25	6.99	7.82	8.71	9.66	10.65	-

Mass flow [kg/s]

$t_c \setminus t_e$	-50	-45	-40	-35	-30	-25	-20	-15	-10
20	57.60	85.95	119.17	158.54	205.36	260.92	326.52	403.45	492.99
25	54.05	81.70	114.20	152.83	198.90	253.68	318.49	394.61	483.32
30	49.89	76.86	108.66	146.57	191.90	245.93	309.96	385.28	473.19
35	45.19	71.50	102.61	139.82	184.43	237.72	300.99	375.53	462.64
40	-	65.66	96.10	132.63	176.53	229.10	291.63	365.41	451.74
45	-	59.41	89.21	125.06	168.28	220.14	281.95	354.98	440.55
50	-	-	81.97	117.18	159.72	210.89	271.99	344.30	429.12
55	-	-	74.45	109.02	150.91	201.41	261.82	333.42	-

Model: D2DB-50 X





Capacity

C.O.P. [W/W]

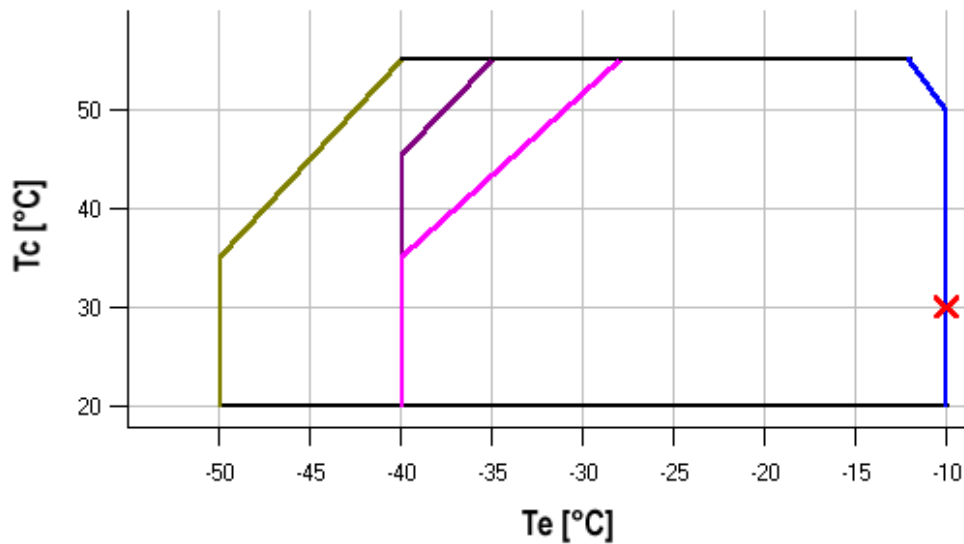
$t_c \setminus t_e$	-50	-45	-40	-35	-30	-25	-20	-15	-10
20	1.46	1.74	2.04	2.39	2.78	3.23	3.77	4.43	5.23
25	1.29	1.55	1.83	2.12	2.45	2.83	3.27	3.78	4.40
30	1.12	1.38	1.63	1.89	2.17	2.48	2.84	3.26	3.74
35	0.96	1.21	1.44	1.67	1.91	2.18	2.48	2.81	3.20
40	-	1.04	1.26	1.47	1.68	1.91	2.15	2.43	2.75
45	-	0.88	1.09	1.28	1.47	1.66	1.87	2.10	2.36
50	-	-	0.93	1.11	1.27	1.44	1.61	1.81	2.02
55	-	-	0.78	0.94	1.09	1.23	1.38	1.54	-

Application range



-  Maximum evaporating temperature
-  25°C suction gas return
-  0°C suction gas return + additional cooling
-  0°C suction gas return

Operating conditions: ISO; subcooling: 0 K, suction superheat: - K, return gas temperature: 20

t_c - Condensing temperature [°C]

t_e - Evaporating temperature [°C]

Model: D2DB-50 X

Dimensions

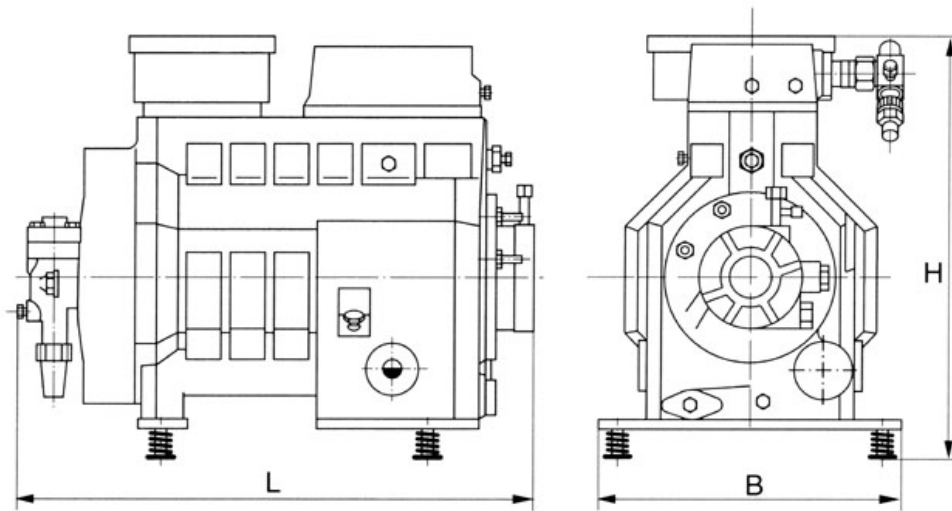

L	590 mm
B	330 mm
H	470 mm

Model: D2DB-50 X

Image

